

**SPECIALISING IN  
CUSTOM MADE  
PRODUCTS**

**AUSTRALIAN MADE**

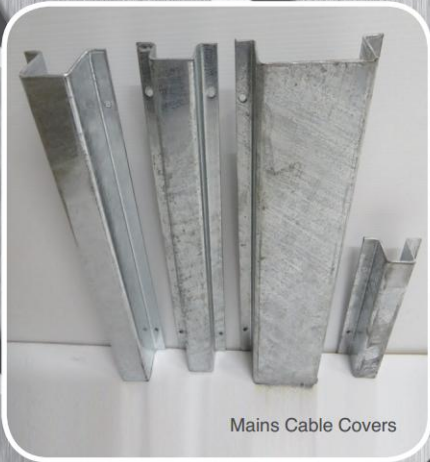

Mains Cable Covers



Pedestal Posts



Cable Handling Equipment



Solar Inverter Enclosures



Lighting Security Cages



Condenser Security Cages

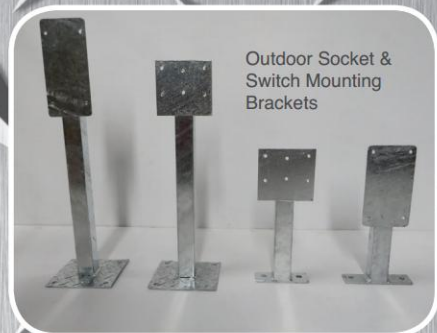

Outdoor Socket & Switch Mounting Brackets

**EFFECTIVE MARCH 2015**

- > Earth Rods & Accessories
- > Cable Protection
- > Lighting, Mains Supply Poles & Riser Brackets
- > Socket & Switch Posts & Mounting Brackets
- > Security Cages & Enclosures
- > Antenna & Mounting Brackets
- > Cable Handling & Tools

40 Starr Avenue North Plympton SA 5037

T 08 8295 5040 > F 08 8295 1688 > E sales@rgbindustries.com.au

[www.rgbmetalproducts.com.au](http://www.rgbmetalproducts.com.au)

## EARTH ROD CONNECTION BOX

Item No.	Description	Specification	M.O.Q
RGB1	Earth Rod Connection Box	75mm x 130mm x 155mm	1
RGB1/C	Earth Rod Connection Box	Custom Sizing	1

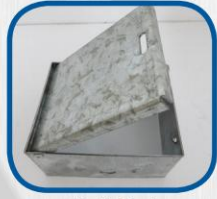

Earth Rod Connection Box

## EARTH ROD ACCESSORIES

Item No.	Description	Specification	M.O.Q
RGB2/3	Earth Rod Clamp	Zinc Plated 16mm	10
RGB2/4	Earth Rod Safety Tag	Zinc Plated	10



Earth Rods Safety Tag

## EARTH RODS GALVANIZED

Item No.	Description	Specification	M.O.Q
RGB2/1	Earth Rod	Galvanised 16mm x 1300mm	10
RGB3/1	Earth Rod, Flag Type	Galvanised 16mm x 1300mm	5
RGB2/CG	Earth Rod	Custom Sizing	1



Earth Rod Clamp

## EARTH RODS STAINLESS STEEL

Item No.	Description	Specification	M.O.Q
RGB2/5	Earth Rod	Stainless Steel 14mm x 1300mm	1
RGB2/6	Earth Rod	Stainless Steel 16mm x 1300mm	1
RGB2/7	Earth Rod	Stainless Steel 20mm x 1300	1
RGB2/9	Earth Rod	Stainless Steel 14mm x 1600mm	1
RGB2/10	Earth Rod	Stainless Steel 14mm x 1800mm	1
RGB2/11	Earth Rod	Stainless Steel 14mm x 2400mm	1
RGB2/12	Earth Rod	Stainless Steel 14mm x 2700mm	1
RGB2/13	Earth Rod	Stainless Steel 16mm x 1500mm	1
RGB2/14	Earth Rod	Stainless Steel 16mm x 1800mm	1
RGB2/15	Earth Rod	Stainless Steel 16mm x 2400mm	1
RGB2/16	Earth Rod	Stainless Steel 16mm x 2700mm	1
RGB2/17	Earth Rod	Stainless Steel 20mm x 1500mm	1
RGB2/18	Earth Rod	Stainless Steel 20mm x 1800mm	1
RGB2/19	Earth Rod	Stainless Steel 20mm x 2400mm	1
RGB2/20	Earth Rod	Stainless Steel 20mm x 2700mm	1
RGB2/CSS	Earth Rod	Custom Sizing	1



Earth Rods

## EARTH RODS COPPER

Item No.	Description	Specification	M.O.Q
RGB2/21	Earth Rod	Copper 16mm x 1300mm	1
RGB2/22	Earth Rod	Copper 2 Pce 16mm x 2400mm	1
RGB2/23	Earth Rod	Copper 20mm x 1300mm	1
RGB2/24	Earth Rod	Copper 2 Pce 20mm x 2400mm	1
RGB2/CC	Earth Rod	Custom Sizing	1

## STOBIE POLE COVERS



Stobie Pole Cover to Suits 25 - 63mm Conduit

Item No.	Description	Specification	M.O.Q
RGB9/6	Stobie mains Pole Cover for 20mm Conduit	2500mm long (white end)	1
RGB9/1	Stobie mains Pole Cover for 25mm Conduit	2500mm long (yellow end)	1
RGB9/2	Stobie mains Pole Cover for 32mm Conduit	2500mm long (red end)	1
RGB9/3	Stobie mains Pole Cover for 40mm Conduit	2500mm long (green end)	1
RGB9/4	Stobie mains Pole Cover for 50mm Conduit	2500mm long (blue end)	1
RGB9/5	Stobie mains Pole Cover for 63mm Conduit	2500mm long (black end)	1

## STOBIE POLE COVERS EDGE MOUNT RECTANGULAR



Edge Mount

Item No.	Description	Specification	M.O.Q
RGB9/11	Stobie Pole Mains Cover suits 102mm Stobie Pole	102mm x 49mm x 3000mm	1
RGB9/12	Stobie Pole Mains Cover suits 150mm Stobie Pole	150mm x 70mm x 3000mm	1
RGB9/14	Stobie Pole Mains Cover suits 180mm Stobie Pole	180mm x 80mm x 3000mm	1
RGB9/18	Stobie Pole Mains Cover suits 102mm Stobie Pole	102mm x 50mm x 3000mm	1



Old Style Face Mount

## STOBIE POLE COVERS FACE MOUNT RECTANGULAR

Item No.	Description	Specification	M.O.Q
RGB9/10	Stobie Pole Mains Cover suits 230mm Stobie Pole Old Style	150mm x 127mm/162mm x 3000mm	1
RGB9/16	Stobie Pole Mains Cover suits 230mm Stobie Pole	226mm x 80mm x 3000mm	1



Face Mount

## MAINS CABLE COVERS

Item No.	Description	Specification W x H x L	M.O.Q
RGB4/1	Mains Cable Cover – 3mm Galv	34mm x 34mm x 450mm (internal)	1
RGB4/2	Mains Cable Cover – 3mm Galv	48mm x 47mm x 450mm (internal)	1
RGB4/3	Mains Cable Cover – 3mm Galv	34mm x 34mm x 225mm (internal)	1
RGB4/4	Mains Cable Cover – 3mm Galv	100mm x 50mm x 450mm (internal)	1
RGB4/5	Mains Cable Cover – 3mm Galv 1 closed end	50mm x 45mm x 1200mm (internal)	1
RGB4/6	Mains Cable Cover – 3mm Galv	50mm x 45mm x 1200mm (internal)	1
RGB4/C	Mains Cable Cover - Custom Sizing	Made to Order	



Mains Cover Type 2

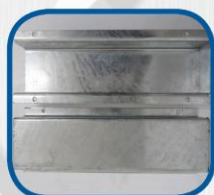

Mains Cover Type 4

## CABLE COVERS/TOP HATS

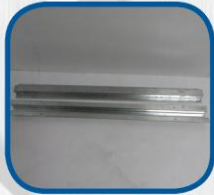

Cable Cover  
50 x 50 x 1200



Mains  
Cable Cover

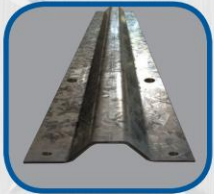

Trapezium Cable Shield

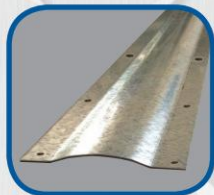

Semi-Circular Cable  
Shield

Item No.	Description	Specification W x H x L	M.O.Q
RGB6/1	Cable Cover – 1.6mm Galv	25mm x 25mm x 1200mm	1
RGB6/2	Cable Cover – 1.6mm Galv	32mm x 32mm x 1200mm	1
RGB6/3	Cable Cover – 1.6mm Galv	38mm x 38mm x 1200mm	1
RGB6/4	Cable Cover – 1.6mm Galv	50mm x 50mm x 1200mm	1
RGB6/5	Cable Cover – 1.6mm Galv	75mm x 75mm x 1200mm	1
RGB6/18	Cable Cover – 1.6mm Galv	100mm x 100mm x 1200mm	1
RGB6/19	Cable Cover – 1.6mm Galv	125mm x 125mm x 1200mm	1
RGB/C	Cable Cover – 1.6mm Galv	Custom	1

## CABLE SHIELDS-TRAPEZIUM

Item No.	Description	Specification W x H x L	M.O.Q
RGB19/1	Trapezium Cable Shield to suit 20mm Conduit 3mm Galv	120mm x 22mm x 1200mm	1
RGB19/2	Trapezium Cable Shield to suit 20mm Conduit 3mm Galv	120mm x 22mm x 2400mm	1
RGB19/3	Trapezium Cable Shield to suit 25mm Conduit 3mm Galv	120mm x 27mm x 1200mm	1
RGB19/4	Trapezium Cable Shield to suit 25mm Conduit 3mm Galv	120mm x 27mm x 2400mm	1
RGB/19C	Trapezium Cable Shield 3mm Galv	Custom	1

## CABLE SHIELDS-SEMI-CIRCULAR

Item No.	Description	Specification W x H x L	M.O.Q
RGB20/1	Semi-Circular Cable Shield to suit 16mm Conduit 3mm Galv	100mm x 22mm x 1200mm	1
RGB20/2	Semi-Circular Cable Shield to suit 16mm Conduit 3mm Galv	100mm x 22mm x 2400mm	1
RGB/20C	Semi-Circular Cable Shield 3mm Galv	Custom	1

# Lighting, Mains Supply Poles & Riser Brackets

## LIGHTING POLES ROUND



Light Pole Round



Light Pole Square

Item No.	Description	Specification W x H x L	M.O.Q
RGB12/10	Round Pole Galv	48mm OD x 1600mm	1
RGB12/11	Round Pole Galv	48mm OD x 3000mm	1
RGB12/12	Round Pole Galv	90mm OD x 6000mm	1
RGB12/13	Round Pole Galv	90mm/76mm OD x 6000mm	1
RGB12/14	Rag Bolt/Cage to suit		1
RGB12/15	Round	100mm OD x 8000mm	1
RGB12/16	Round	100mm/90mm/76mm OD x 8000mm	1

## LIGHTING POLES SQUARE

Item No.	Description	Specification W x H x L	M.O.Q
RGB12/17	Square Galv	100mm x 100mm x 6000mm	1
RGB12/18	Square Galv	100mm x 100mm x 8000mm	1
RGB12/19	Rag Bolt/Cage to suit		1
RGB12/C	Light Pole	Custom	1

## MAINS SUPPLY POLES



Mains Supply Support Pole

Item No.	Description	Specification	M.O.Q
RGB12/1	Mains Supply Support Pole - galv	80 NB x 7400mm Galv Pipe	1
RGB12/2	Mains Supply Support Pole - galv	75mm x 75mm x 7400mm Galv RHS	1
RGB12/C	Mains Supply Pole	Custom	1

## RISER BRACKETS



Cable Hanger Bracket - Single & Three Phase

Item No.	Description	Specification	M.O.Q
RGB5	Cable Hanger Riser Bracket 1PH under fascia mount	900mm high	1
RGB8	Cable Hanger Riser Bracket 3PH under fascia mount	900mm high	1
RGB5/2	Cable Hanger Bracket 1PH fascia mount	200mm high	1

# Socket & Switch Posts & Mounting Brackets

## OUTDOOR BRACKETS

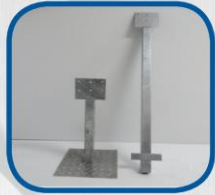

Outdoor Bracket - Single Phase

Item No.	Description	Specification	M.O.Q
RGB10/1	Outdoor Mounting Bracket - 1PH outlet	950mm x 40mm sq	1
RGB10/2	Outdoor Mounting Bracket - 3PH outlet	950mm x 40mm sq	1
RGB10/3	Outdoor Mounting Bracket - 1PH outlet	450mm x 40mm sq w/base plate	1
RGB10/4	Outdoor Mounting Bracket - 3PH outlet	450mm x 40mm sq w/base plate	1
RGB10/10	Outdoor Mounting Bracket Isolator for 56 series	300mm x 40mm sq w/base bar	1
RGB10/11	Outdoor Mounting Bracket - 1PH outlet	300mm x 40mm sq w/base bar	1
RGB10/C	Outdoor Mounting Bracket	Custom	1



Outdoor Bracket - Three Phase

## PEDESTAL POSTS



Outlet

Item No.	Description	Specification	M.O.Q
RGB10/12	Accepts 1x56 series outlet & switch hot dipped galv	100mm x 100mm x 500mm sq post 125mm x 125mm base mounting plate	1
RGB10/12C	Accepts 1x56 series outlet & switch hot dipped galv	Custom Sizing	1
RGB10/13	Accepts 2x56 series outlet & switch hot dipped galv	100mm x 100mm x 500mm sq post 125mm x 125mm base mounting plate	1
RGB10/13C	Accepts 2x56 series outlet & switch hot dipped galv	Custom Sizing	1
RGB10/C	Pedestal Post	Custom	1

## PENDANT BRACKETS

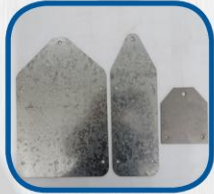

Single & Three Phase  
Pendant Mounting  
Brackets

Item No.	Description	Specification	M.O.Q
RGB10/5	Pendant Mounting Bracket	3PH Single o/let	5
RGB10/6	Pendant Mounting Bracket	3PH Double o/let	5
RGB10/7	Pendant Mounting Bracket	3PH Triple o/let	5
RGB10/8	Pendant Mounting Bracket	1PH Double o/let	5
RGB10/9	Pendant Mounting Bracket	3PH Switch only	5
RGB10/C	Pendant Brackets	Custom	1

# Security Cages & Enclosures

## WALL MOUNT LIGHTING GUARD



Lighting Guards –  
Wall Mount

Item No.	Description	Specification W x H x D	M.O.Q
RGB7/14	Lighting Guard: wall mount (closed ends)	200mm x 200mm x 200mm	1
RGB7/15	Lighting Guard: wall mount (closed ends)	800mm x 200mm x 200mm	1
RGB7/16	Lighting Guard: wall mount (closed ends)	1350mm x 200mm x 200mm	1
RGB7/17	Lighting Guard: wall mount (closed ends)	300mm x 300mm x 300mm	1
RGB7/18	Lighting Guard: wall mount (closed ends)	400mm x 400mm x 400mm	1
RGB7/19	Lighting Guard: wall mount (closed ends)	500mm x 500mm x 500mm	1
RGB7/20	Lighting Guard: wall mount (closed ends)	600mm x 600mm x 600mm	1
RGB7/21	Lighting Guard: wall mount (closed ends)	600mm x 750mm x 350mm	1
RGB7/CW	Lighting Guard: wall mount (closed ends)	Custom Sizing	1

## FLOOR MOUNT LIGHTING GUARD



Lighting Protective Cage  
– Floor mount

RGB7/22	Lighting Guard: floor mount (fixing flange)	200mm x 200mm x 200mm	1
RGB7/23	Lighting Guard: floor mount (fixing flange)	800mm x 200mm x 200mm	1
RGB7/24	Lighting Guard: floor mount (fixing flange)	1350mm x 200mm x 200mm	1
RGB7/25	Lighting Guard: floor mount (fixing flange)	300mm x 300mm x 300mm	1
RGB7/26	Lighting Guard: floor mount (fixing flange)	400mm x 400mm x 400mm	1
RGB7/27	Lighting Guard: floor mount (fixing flange)	500mm x 500mm x 500mm	1
RGB7/28	Lighting Guard: floor mount (fixing flange)	600mm x 600mm x 600mm	1
RGB7/29	Lighting Guard: floor mount (fixing flange)	600mm x 750mm x 350mm	1
RGB7/CF	Lighting Guard: floor mount (fixing flange)	Custom Sizing	1

## CEILING MOUNT LIGHTING GUARD



Lighting Guards –  
Ceiling Mount

RGB7/30	Lighting Guard: ceiling mount (open ends)	200mm x 200mm x 200mm	1
RGB7/31	Lighting Guard: ceiling mount (open ends)	800mm x 200mm x 200mm	1
RGB7/32	Lighting Guard: ceiling mount (open ends)	1350mm x 200mm x 200mm	1
RGB7/33	Lighting Guard: ceiling mount (open ends)	300mm x 300mm x 300mm	1
RGB7/CC	Lighting Guard: ceiling mount (open ends)	Custom Sizing	1

## EXIT LIGHT GUARDS



Exit Light Guards

RGB7/40	Exit Light Guard Galv	375mm x 250mm x 125mm	1
RGB7/41	Exit Light Guard Galv	650mm x 300mm x 200mm	1
RGB7/C	Exit Light Guard Galv	Custom Sizing	1

Powder coating available at extra cost

**Quantity discounts available**

## SOLAR INVERTER ENCLOSURES

Item No.	Description	Specification W x H x D	M.O.Q
RGB17/1	Solar Inverter cage:front opening hinged door	800W x 1200H x 400mm	1
RGB17/2	Solar Inverter cage:front opening hinged door	1500W x 1000H x 430mm	1
RGB17/3	Custom Solar Inverter cage		1



Solar Inverter Cage



Flat Pack  
Condenser Cage



Air Conditioning  
Condenser Cage



Air Conditioning  
Condenser Cage



Universal Cantilever  
Bracket



Antenna Bracket



Cable Mate 20/50

## AIR CONDITIONING CONDENSER CAGES

Item No.	Description	Specification W x H x D	M.O.Q
RGB0909/25	Air Con Condenser Cages - 25mm Mesh	900mm x 900mm x 600mm	1
RGB1009/25	Air Con Condenser Cages - 25mm Mesh	1000mm x 900mm x 600mm	1
RGB1210/25	Air Con Condenser Cages - 25mm Mesh	1200mm x 1000mm x 600mm	1
RGB1212/25	Air Con Condenser Cages - 25mm Mesh	1200mm x 1200mm x 600mm	1
RGB1214/25	Air Con Condenser Cages - 25mm Mesh	1200mm x 1400mm x 600mm	1
RGB1216/25	Air Con Condenser Cages - 25mm Mesh	1200mm x 1600mm x 600mm	1
RGB0909/50	Air Con Condenser Cages - 50mm Mesh	900mm x 900mm x 600mm	1
RGB1009/50	Air Con Condenser Cages - 50mm Mesh	1000mm x 900mm x 600mm	1
RGB1210/50	Air Con Condenser Cages - 50mm Mesh	1200mm x 1000mm x 600mm	1
RGB1212/50	Air Con Condenser Cages - 50mm Mesh	1200mm x 1200mm x 600mm	1
RGB1214/50	Air Con Condenser Cages - 50mm Mesh	1200mm x 1400mm x 600mm	1
RGB1216/50	Air Con Condenser Cages - 50mm Mesh	1200mm x 1600H x 600mm	1

# Antenna & Mounting Brackets

## MOUNTING BRACKETS

Item No.	Description	Specification	M.O.Q
RGB 14/1	Cantilever Mounting Bracket	Galv 300mm long (no brace)	1
RGB 14/2	Cantilever Mounting Bracket	Galv 450mm long (braced)	1
RGB 14/3	Cantilever Mounting Bracket	Galv 600mm long (braced)	1

## ANTENNA BRACKETS

Item No.	Description	Specification	M.O.Q
RGB15/1	Antenna Bracket: fascia mount	1400mm high	1
RGB15/2	Antenna Bracket: fascia mount	1800mm high	1

# Cable Handling & Tools

## CABLE HANDLING EQUIPMENT

Item No.	Description	Specification	M.O.Q
RGB11/3	Cablemate 20 Cable Drum Stand	300mm x 300mm (S.W.L. 20kg)	1
RGB11/1	Cablemate 50 Cable Drum Stand	440mm x 1000mm (S.W.L. 50kg)	1
RGB11/2	Cablemate 100 Cable Drum Stand	500 x 1000mm (S.W.L. 100kg)	1

## SERVICE PIT LID LIFTER



Junction Pit Lifter

Item No.	Description	Specification	M.O.Q
RGB16/3	Lid Lifter - Junction Pit	680mm	1
RGB16/4	Lid Lifter - Junction Pit	240mm	1

## LIGHT STAND



Light Stand

Item No.	Description	Specification	M.O.Q
RGB13/1	Light Stand	1800mmH	1

## Cable Cover Made to Order

Please complete details  
and email  
[sales@rgbindustries.com.au](mailto:sales@rgbindustries.com.au)  
or fax **08 8295 1688**.

Please contact  
**8295 5040** if you require more  
information.

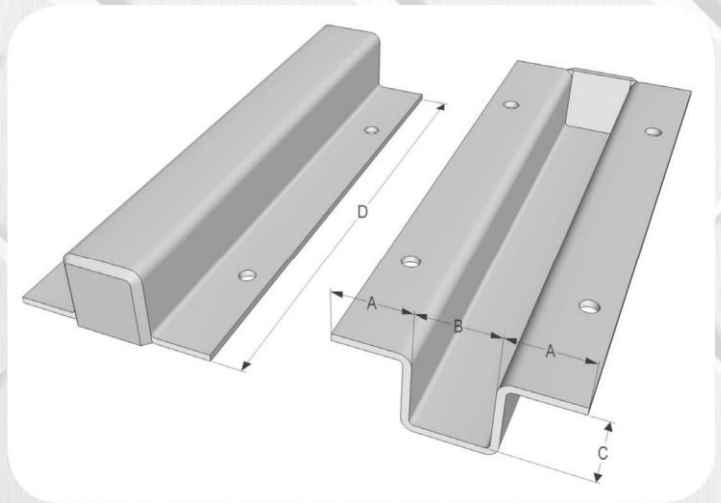

	Specifications		Other
Fixing Flange	A		mm
Width Internal	B		mm
Depth Internal	C		mm
Length Overall	D		mm
Material Thickness	0.6mm <input type="checkbox"/>	1.6mm <input type="checkbox"/>	3.0mm <input type="checkbox"/>
Material Type	Galvabond <input type="checkbox"/>		Zincanneal <input type="checkbox"/>
	Open Both Ends <input type="checkbox"/>		Closed One End <input type="checkbox"/>
Finish	Unpainted <input type="checkbox"/>	Painted <input type="checkbox"/>	Powder Coated <input type="checkbox"/>
Other			
Quantity			

Company Name: \_\_\_\_\_

Order No.: \_\_\_\_\_

Contact Name: \_\_\_\_\_

Phone: \_\_\_\_\_

Fax: \_\_\_\_\_

Email: \_\_\_\_\_